

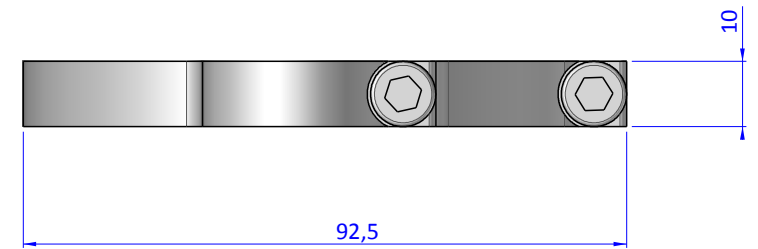

THE PROPERTY OF THE DRAWING IS ESTABLISHED BY LAW. IT IS FORBIDDEN TO PRODUCE OR SHOW IT TO THIRD PARTY, WITHOUT A WRITTEN AGREEMENT.

Item	Name	Q.ty
1	R.6.SCH	2
2	SAT.7520.L	1
3	V.TCE6x18	2

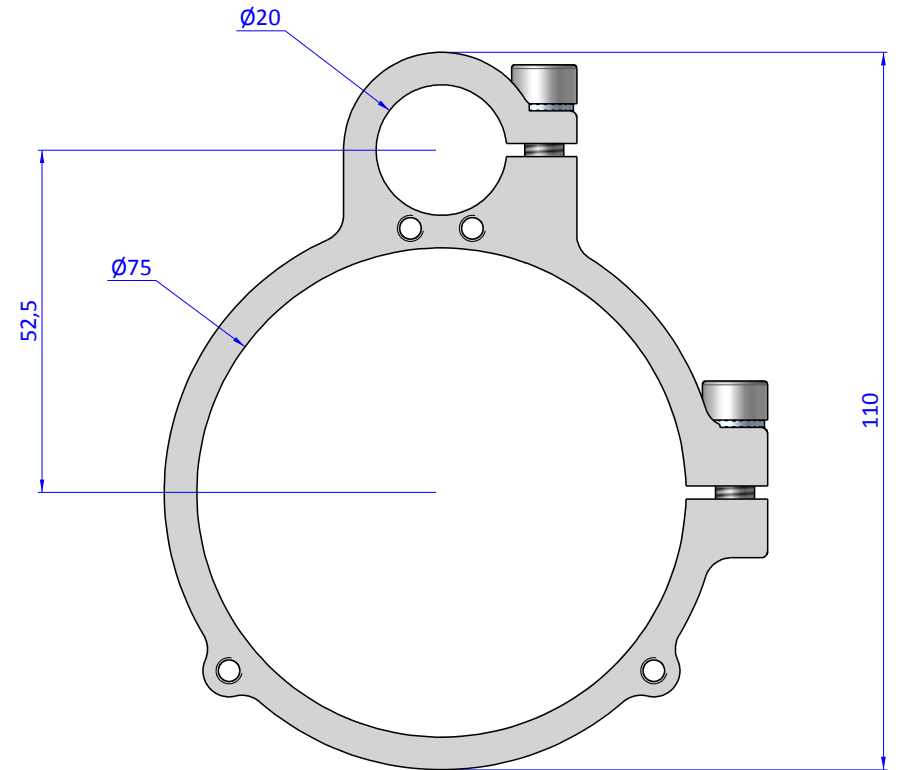
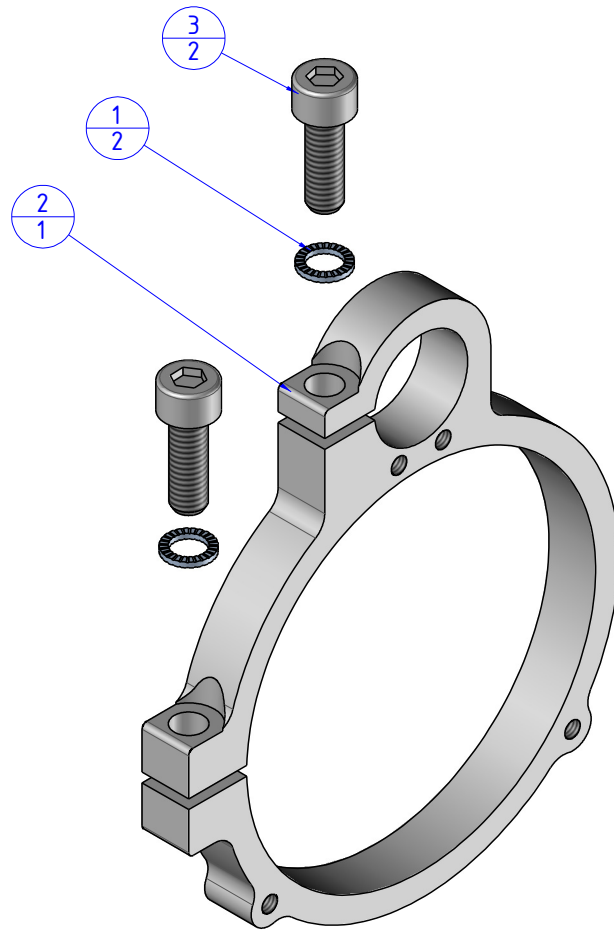

Format A3

UNI 936-76

 FPS SERVICES AUTOMATION		DESIGNED FROM		REVIEW
		FPS Automation		A
GENERAL TOLERANCE		DATE	WEIGHT	
UNI - ISO 2768		16/05/2019	0.054 Kg	
CLASSE f	DESCRIPTION	CODE		
	CA.SAT.7520	CA.SAT.7520		